

30 ELEVATION-ENTRY/ PRODUCE/ SEAFOOD
A3.2 SCALE: 1/4" = 1'-0"

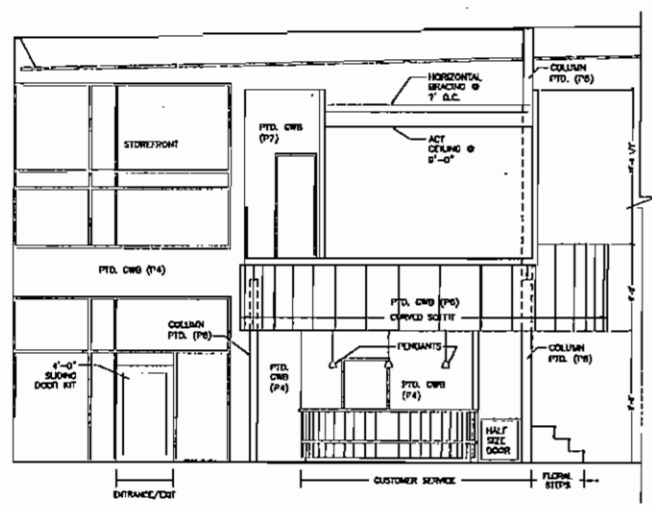

40 ELEVATION-EXIT/ CUSTOMER SERVICE
A3.2 SCALE: 1/4" = 1'-0"

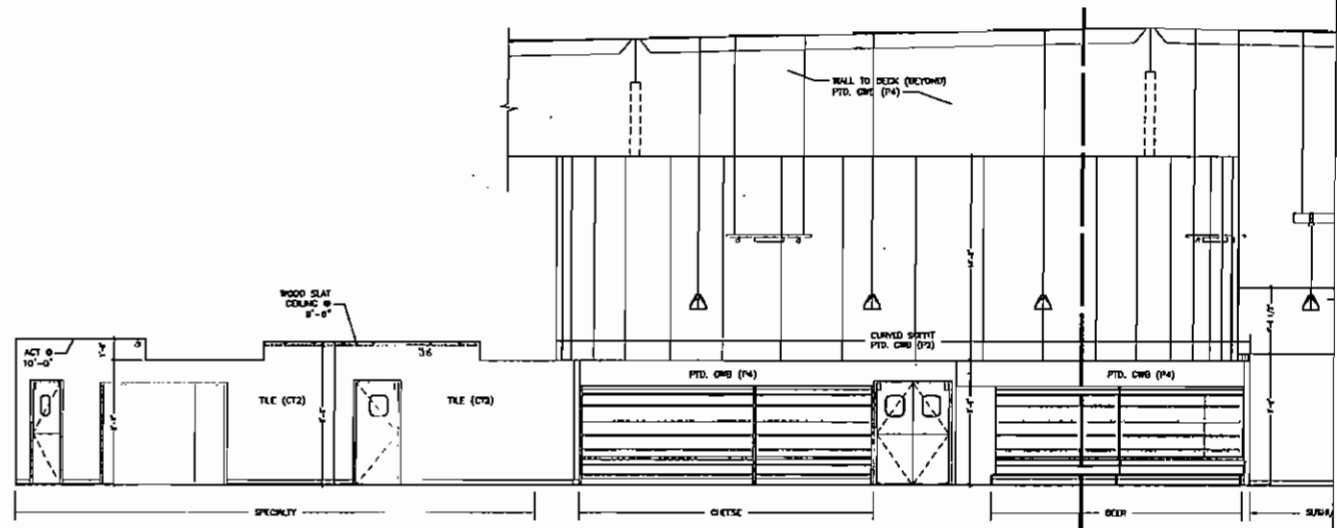

22 ELEVATION-SPECIALTY/ PREPARED FOODS
A3.2 SCALE: 1/4" = 1'-0"

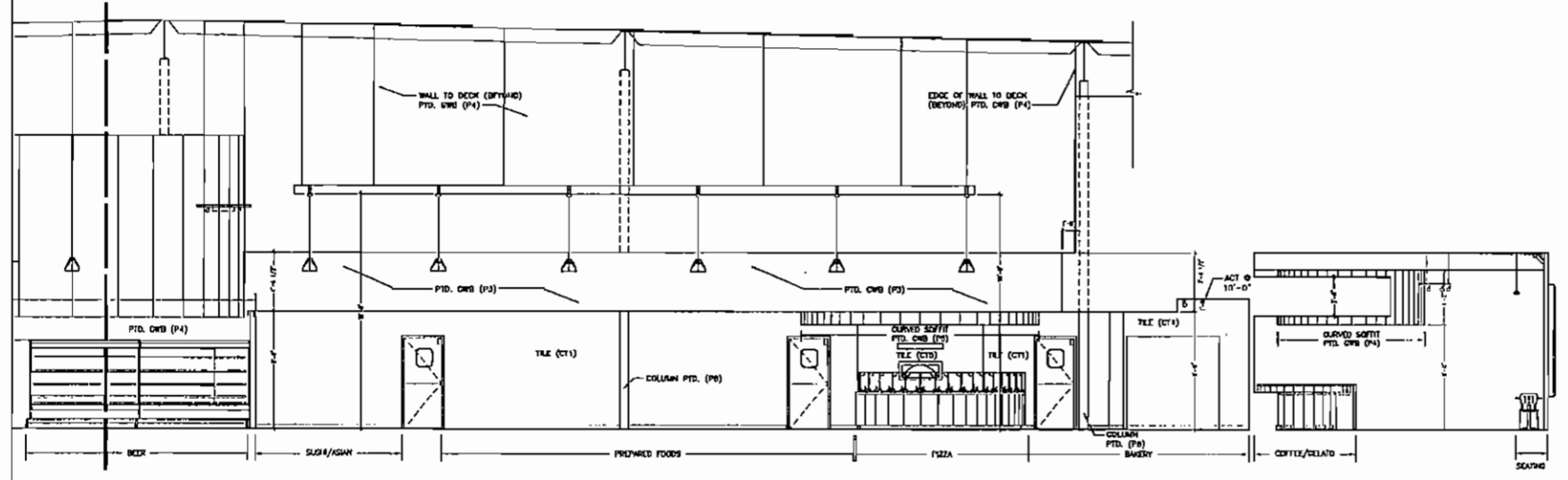

42 ELEVATION-SPECIALTY/ PREPARED FOODS
A3.2 SCALE: 1/4" = 1'-0"

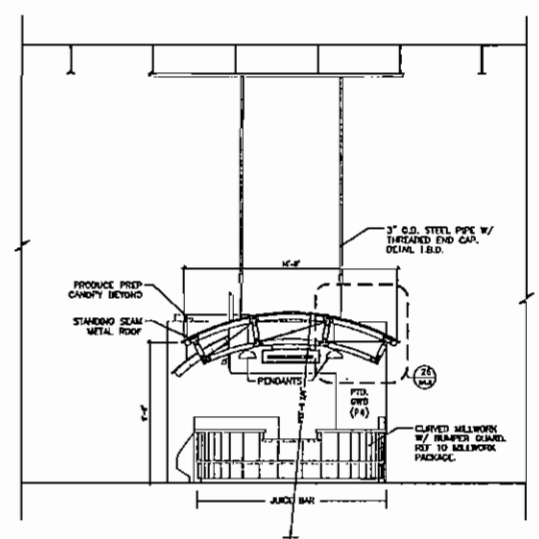

CONTRACTOR'S NOTE:
This drawing is the property of the Architect. It is to be used for the project only and is not to be reproduced or used for any other project without the written consent of the Architect. The Contractor shall be responsible for obtaining all necessary permits and for the proper installation of all materials and equipment shown on this drawing.

NO.	REVISION
1	ISSUED FOR PERMIT
2	REVISED
3	REVISED
4	REVISED
5	REVISED
6	REVISED
7	REVISED
8	REVISED
9	REVISED
10	REVISED
11	REVISED
12	REVISED
13	REVISED
14	REVISED
15	REVISED
16	REVISED
17	REVISED
18	REVISED
19	REVISED
20	REVISED
21	REVISED
22	REVISED
23	REVISED
24	REVISED
25	REVISED
26	REVISED
27	REVISED
28	REVISED
29	REVISED
30	REVISED
31	REVISED
32	REVISED
33	REVISED
34	REVISED
35	REVISED
36	REVISED
37	REVISED
38	REVISED
39	REVISED
40	REVISED
41	REVISED
42	REVISED
43	REVISED
44	REVISED
45	REVISED
46	REVISED
47	REVISED
48	REVISED
49	REVISED
50	REVISED

PROFESSIONAL IN CHARGE
ARCHITECT
PROJECT MANAGER
ARCHITECT
QUALITY CONTROL
ARCHITECT
DESIGNED BY
ARCHITECT/ARCHITECT

NASHVILLE
TENNESSEE
HILL CENTER



PROJECT NUMBER
20050458
SHEET TITLE

INTERIOR
ELEVATIONS

SHEET NUMBER
A3.2

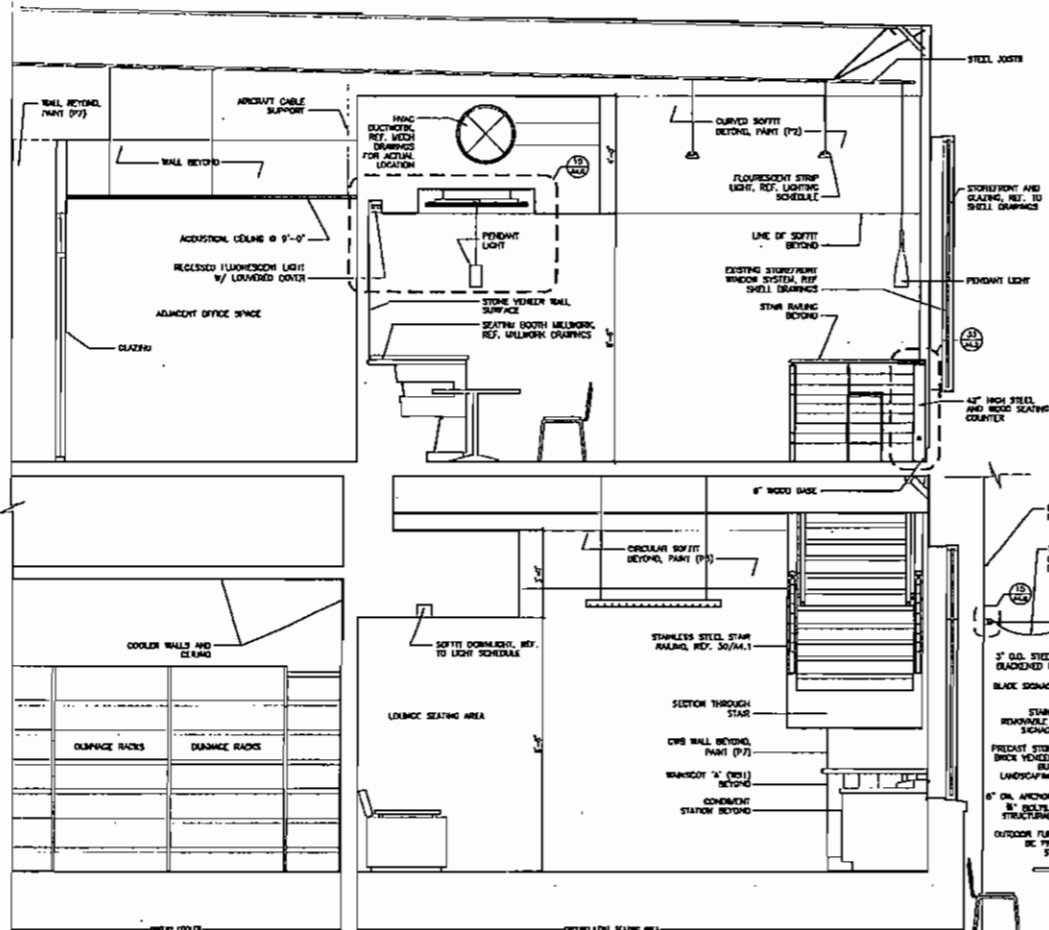

39 SECTION-SEATING/OUTDOOR DINING
A4.0 SCALE: 1/2" = 1'-0"

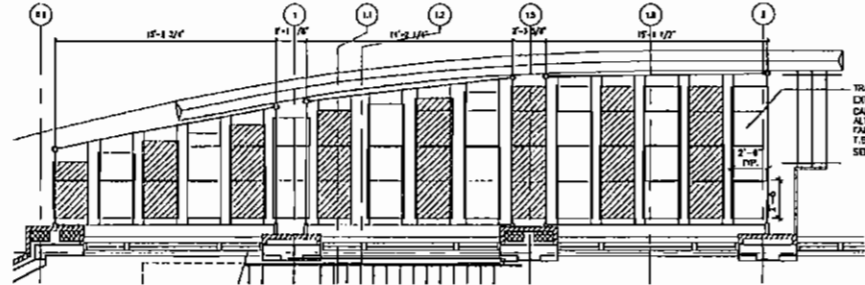

40 OUTDOOR FABRIC CANOPY-PLAN
A4.0 SCALE: 1/4" = 1'-0"

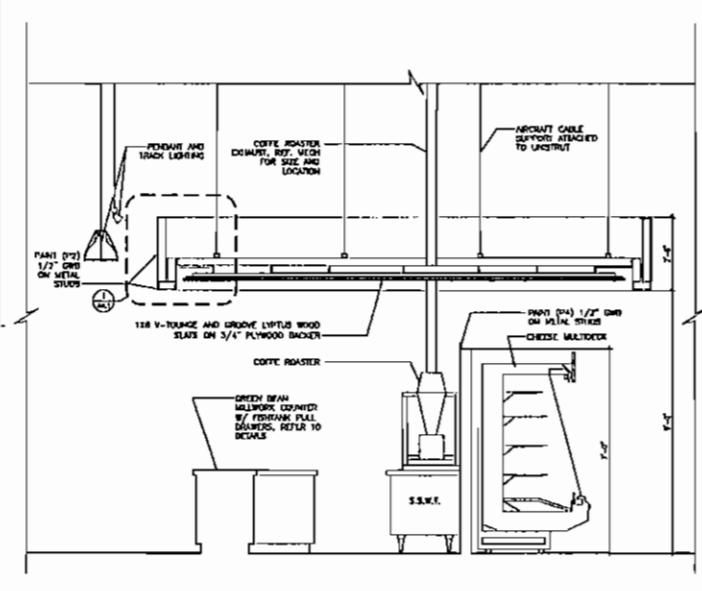

42 SECTION-COFFEE ROASTER
A4.0 SCALE: 1/2" = 1'-0"

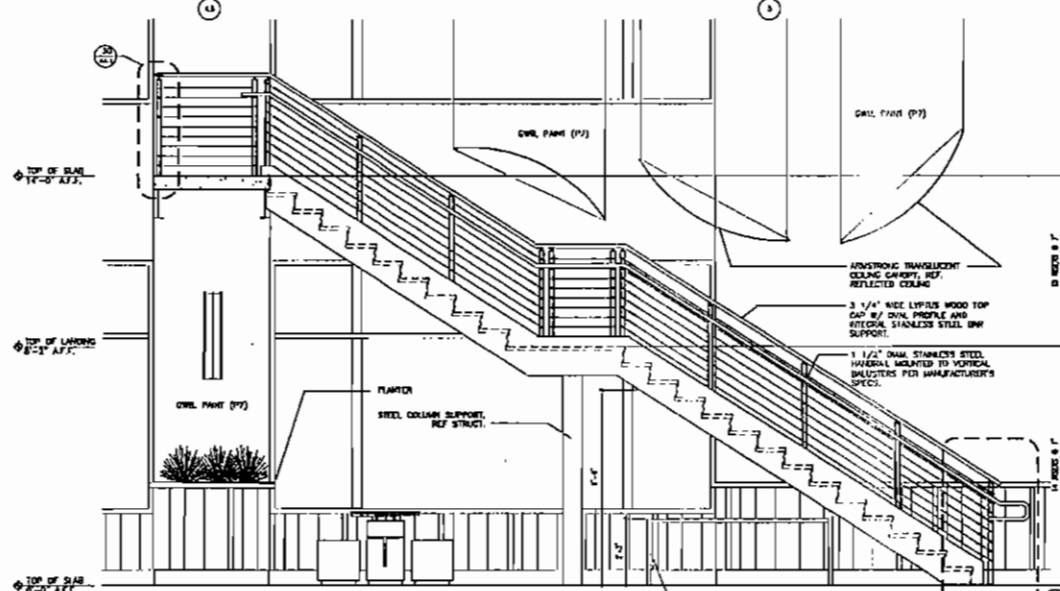

30 SECTION-STAIR
A4.0 SCALE: 1/2" = 1'-0"

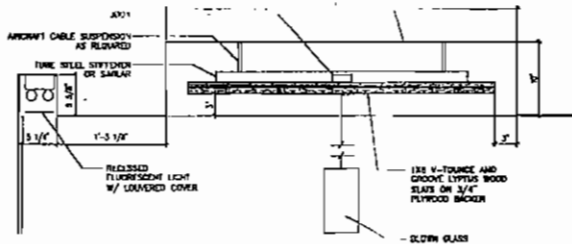

19 CANOPY DETAIL-MEZZ. SEATING
A4.0 SCALE: 1 1/2" = 1'-0"

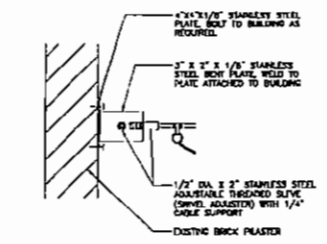

ELEVATION

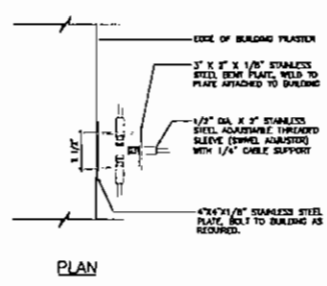

PLAN

15 DETAIL-BOOTH CANOPY
A4.0 SCALE: 3" = 1'-0"

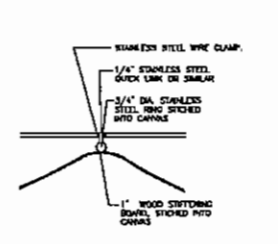

7 DETAIL-BOOTH CANOPY
A4.0 SCALE: 3" = 1'-0"

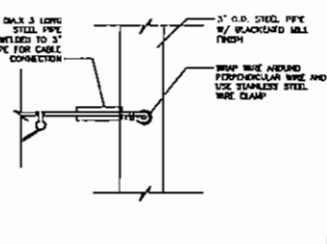

1 DETAIL-BOOTH CANOPY
A4.0 SCALE: 3" = 1'-0"

8 CANOPY DETAIL-PRODUCE PREP
A4.0 SCALE: 3" = 1'-0"

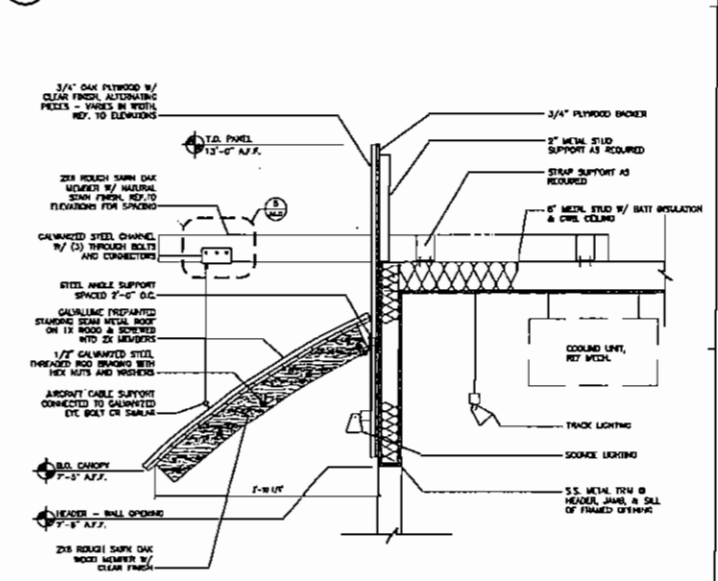

10 SECTION DETAIL-PRODUCE PREP
A4.0 SCALE: 1" = 1'-0"

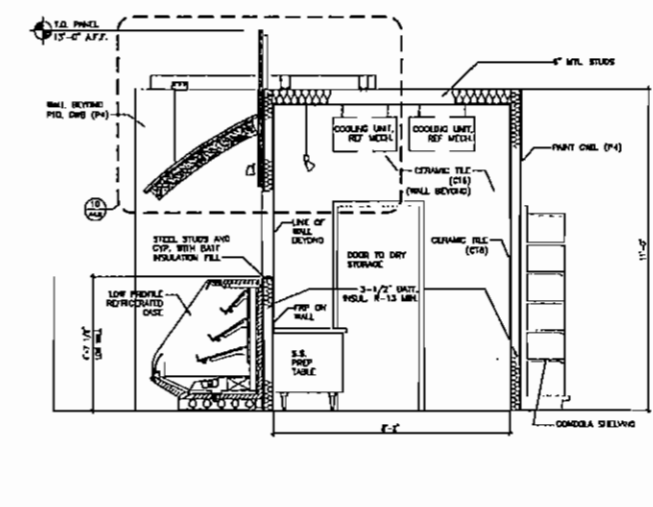

11 SECTION-PRODUCE PREP
A4.0 SCALE: 1/2" = 1'-0"

ARCHITECT: A4.0
 PROJECT NAME: NASHVILLE TENNESSEE HILL CENTER
 WHOLE FOODS MARKET
 SHEET NUMBER: A4.0
 TO ORDER PLAN: WWW.LDIREPRO.COM

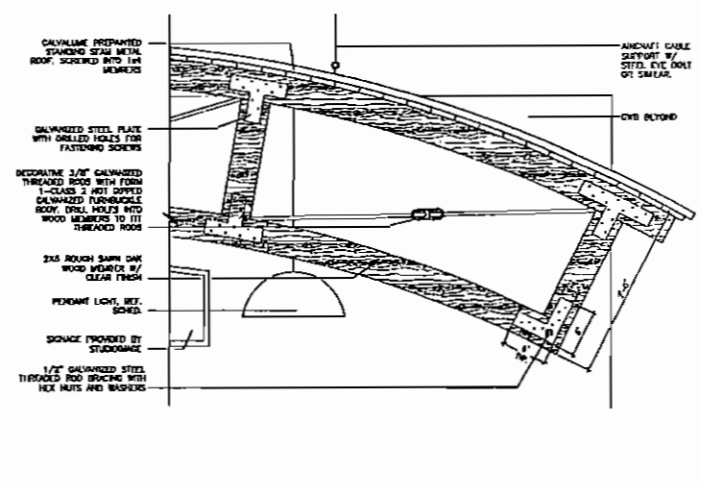

28 SECTION-JUICE BAR
 A4.2 SCALE: 1/2" = 1'-0"

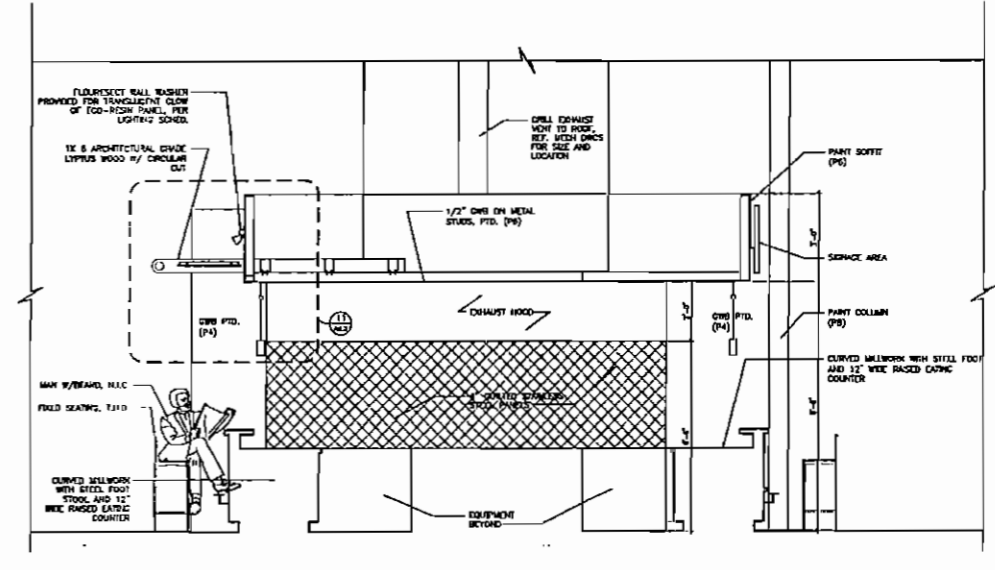

14 SECTION-SEAFOOD ISLAND
 A4.2 SCALE: 1/2" = 1'-0"

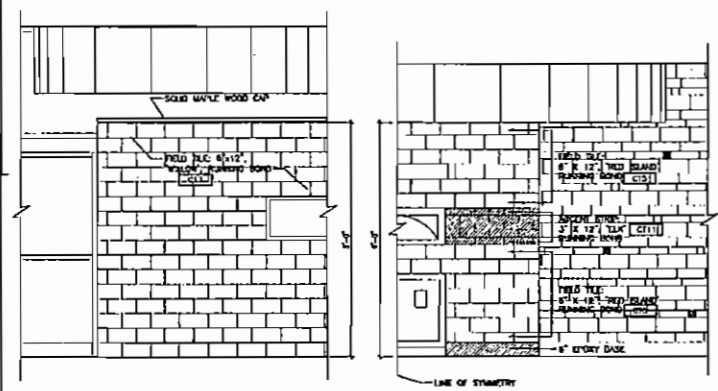

40 TILE PATTERN-FLORAL AREA
 A4.2 SCALE: 1/2" = 1'-0"

34 TILE PATTERN-PIZZA WALL
 A4.2 SCALE: 1/2" = 1'-0"

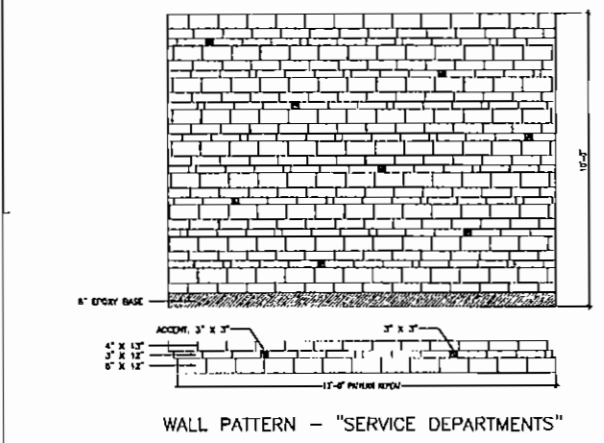

42 TILE PATTERN-SERVICE AREAS
 A4.2 SCALE: 1/2" = 1'-0"

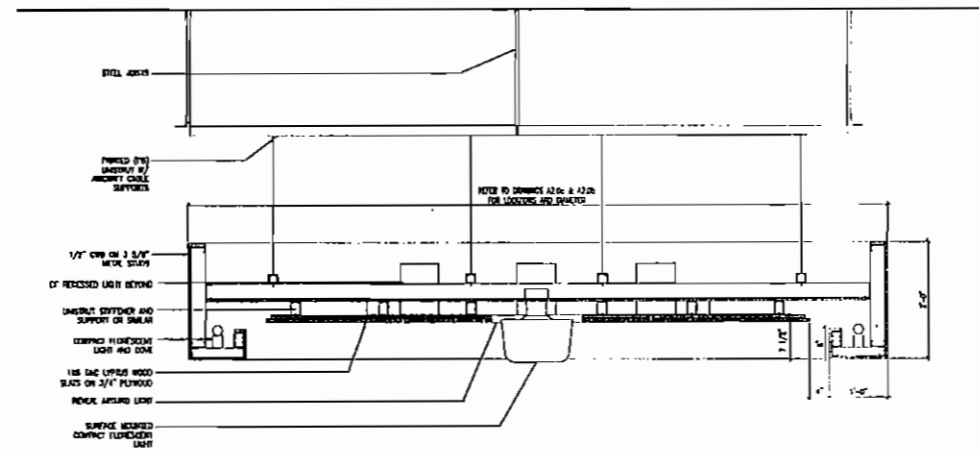

20 CEILING @ MEZZANINE
 A4.2 SCALE: 1" = 1'-0"

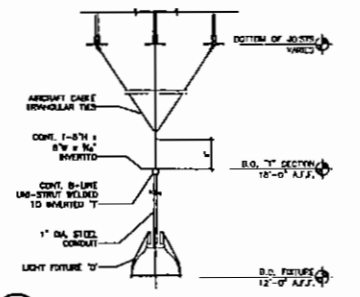

24 PENDANT SUPPORT-PREP FOODS
 A4.2 SCALE: 3/4" = 1'-0"

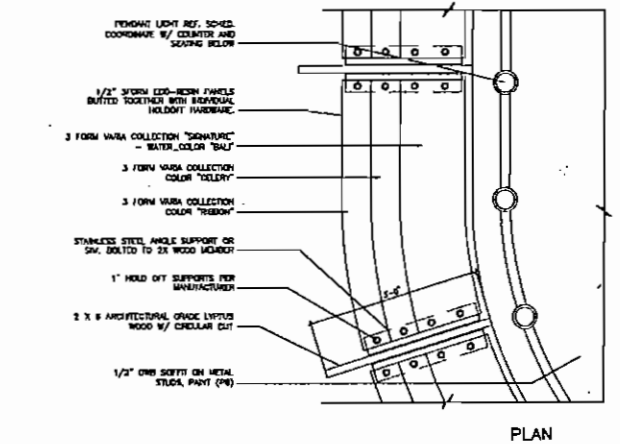

11 DETAIL & PLAN-SEAFOOD ISLAND
 A4.2 SCALE: 1" = 1'-0"

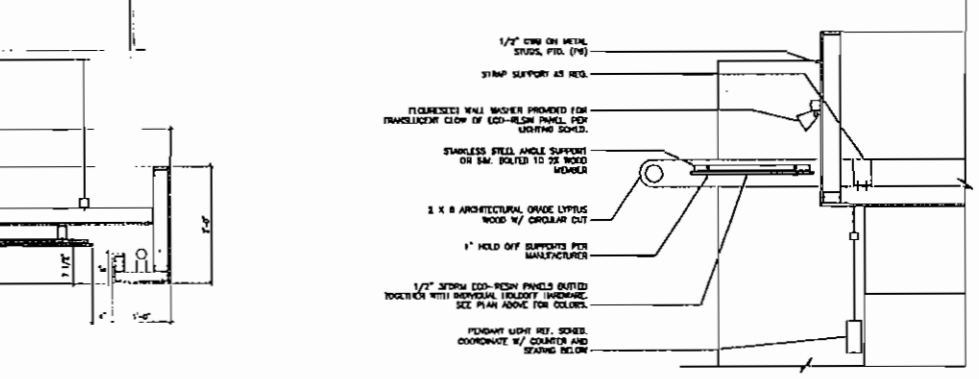

SECTION

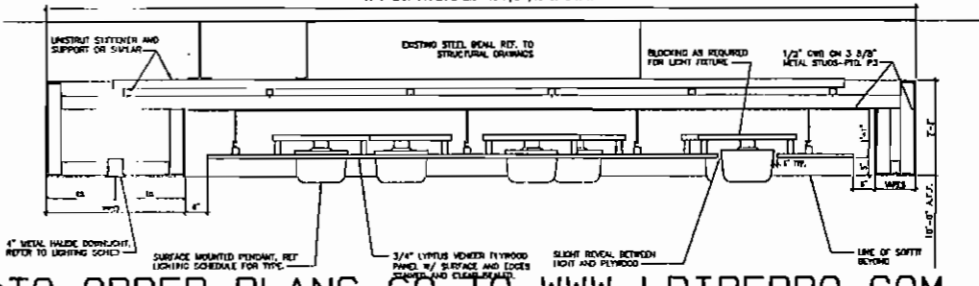

18 SECTION-COUNTER SEATING
 A4.2 SCALE: 3/4" = 1'-0"

CONTRACT NO. 20050458

NO. DRAWING 28, 14, 40, 34, 20, 24, 11, 18

DATE 05/15/05

PROJECT NAME

PROFESSIONAL SEAL

PROFESSIONAL IN CHARGE
 LINDSEY BONDEN
 PROJECT MANAGER
 ALAN MITCHELL
 QUALITY ENGINEER
 WENDY DRY
 DESIGNED BY
 JONATHAN HOFFMAN/AJCA JONES

NASHVILLE
 TENNESSEE
 HILL CENTER



PROJECT NUMBER
 20050458

SECTIONS AND DETAILS

PROJECT NUMBER
 20050458

A4.2

TO ORDER PLANS GO TO WWW.LDIREPRO.COM

ROOM FINISH SCHEDULE REMARKS:

1. FINISH VINYL BASE AS EXPOSED ONT. DO WALLS NOT COVERED WITH TILE OR MANGOOT
2. SEE TILE PATTERN (SLY. 18/A1.1)
3. SEE TILE PATTERN (SLY. 22/A1.1)
4. FINISH FULL HT. FIN TO UNDERSIDE OF CEILING
5. SEE TILE PATTERN (SLY. 42/A4.3)
6. SEE DTL. 19/A5.0 FOR EPOXY COVE BASE.
7. PAINT COLUMNS IN SALES AREA [P8]
8. SET INTERIOR ELEVATIONS SHEETS ALSO ALSO FOR WALL FINISHES.
9. SET FLOOR FINISH PLAN SHEET A1.3 FOR FLOOR FINISHES.
10. SEE WALL FINISH PLAN SHEET A1.4 FOR WALL FINISHES.
11. DIVISION BIDDING/NOTES - 1/2" DANDA BURL (FULL FULL WATER CONVERSION VARNISH) +/- MEDIUM BLEND OFFICE) & 1/2" DANDA BURL (FULL FULL WATER CONVERSION VARNISH) +/- MEDIUM BLEND OFFICE) & 1/2" DANDA BURL (FULL FULL WATER CONVERSION VARNISH) +/- MEDIUM BLEND OFFICE) & 1/2" DANDA BURL (FULL FULL WATER CONVERSION VARNISH) +/- MEDIUM BLEND OFFICE)
12. FINISH BLOCCING AT 5'-0", 6'-0", & 7'-0" AFF. ON ALL WALLS

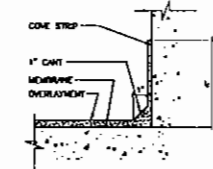

19 EPOXY COVE BASE
AS.O SCALE 3" = 1'-0"

ROOM FINISH SCHEDULE

NO.	NAME	FLOOR	BASE	WALLS	CEILING	CEILING HEIGHT	REMARKS	NO.
100	SALES	WALLS	WALLS	WALLS	P8	11'-0"	WALLS	100
101	SALES	CONC1	CONC1	CONC1	P8	11'-0"	WALLS	101
102	SALES	CONC1	CONC1	CONC1	P8	11'-0"	WALLS	102
103	SALES	CONC1	CONC1	CONC1	P8	11'-0"	WALLS	103
104	SALES	CONC1	CONC1	CONC1	P8	11'-0"	WALLS	104
105	SALES	CONC1	CONC1	CONC1	P8	11'-0"	WALLS	105
106	SALES	CONC1	CONC1	CONC1	P8	11'-0"	WALLS	106
107	SALES	CONC1	CONC1	CONC1	P8	11'-0"	WALLS	107
108	SALES	CONC1	CONC1	CONC1	P8	11'-0"	WALLS	108
109	SALES	CONC1	CONC1	CONC1	P8	11'-0"	WALLS	109
110	SALES	CONC1	CONC1	CONC1	P8	11'-0"	WALLS	110
111	SALES	CONC1	CONC1	CONC1	P8	11'-0"	WALLS	111
112	SALES	CONC1	CONC1	CONC1	P8	11'-0"	WALLS	112
113	SALES	CONC1	CONC1	CONC1	P8	11'-0"	WALLS	113
114	SALES	CONC1	CONC1	CONC1	P8	11'-0"	WALLS	114
115	SALES	CONC1	CONC1	CONC1	P8	11'-0"	WALLS	115
116	SALES	CONC1	CONC1	CONC1	P8	11'-0"	WALLS	116
117	SALES	CONC1	CONC1	CONC1	P8	11'-0"	WALLS	117
118	SALES	CONC1	CONC1	CONC1	P8	11'-0"	WALLS	118
119	SALES	CONC1	CONC1	CONC1	P8	11'-0"	WALLS	119
120	SALES	CONC1	CONC1	CONC1	P8	11'-0"	WALLS	120
121	SALES	CONC1	CONC1	CONC1	P8	11'-0"	WALLS	121
122	SALES	CONC1	CONC1	CONC1	P8	11'-0"	WALLS	122
123	SALES	CONC1	CONC1	CONC1	P8	11'-0"	WALLS	123
124	SALES	CONC1	CONC1	CONC1	P8	11'-0"	WALLS	124
125	SALES	CONC1	CONC1	CONC1	P8	11'-0"	WALLS	125
126	SALES	CONC1	CONC1	CONC1	P8	11'-0"	WALLS	126
127	SALES	CONC1	CONC1	CONC1	P8	11'-0"	WALLS	127
128	SALES	CONC1	CONC1	CONC1	P8	11'-0"	WALLS	128
129	SALES	CONC1	CONC1	CONC1	P8	11'-0"	WALLS	129
130	SALES	CONC1	CONC1	CONC1	P8	11'-0"	WALLS	130
131	SALES	CONC1	CONC1	CONC1	P8	11'-0"	WALLS	131
132	SALES	CONC1	CONC1	CONC1	P8	11'-0"	WALLS	132
133	SALES	CONC1	CONC1	CONC1	P8	11'-0"	WALLS	133
134	SALES	CONC1	CONC1	CONC1	P8	11'-0"	WALLS	134
135	SALES	CONC1	CONC1	CONC1	P8	11'-0"	WALLS	135
136	SALES	CONC1	CONC1	CONC1	P8	11'-0"	WALLS	136
137	SALES	CONC1	CONC1	CONC1	P8	11'-0"	WALLS	137
138	SALES	CONC1	CONC1	CONC1	P8	11'-0"	WALLS	138
139	SALES	CONC1	CONC1	CONC1	P8	11'-0"	WALLS	139
140	SALES	CONC1	CONC1	CONC1	P8	11'-0"	WALLS	140
141	SALES	CONC1	CONC1	CONC1	P8	11'-0"	WALLS	141
142	SALES	CONC1	CONC1	CONC1	P8	11'-0"	WALLS	142
143	SALES	CONC1	CONC1	CONC1	P8	11'-0"	WALLS	143
144	SALES	CONC1	CONC1	CONC1	P8	11'-0"	WALLS	144
145	SALES	CONC1	CONC1	CONC1	P8	11'-0"	WALLS	145
146	SALES	CONC1	CONC1	CONC1	P8	11'-0"	WALLS	146
147	SALES	CONC1	CONC1	CONC1	P8	11'-0"	WALLS	147
148	SALES	CONC1	CONC1	CONC1	P8	11'-0"	WALLS	148
149	SALES	CONC1	CONC1	CONC1	P8	11'-0"	WALLS	149
150	SALES	CONC1	CONC1	CONC1	P8	11'-0"	WALLS	150
151	SALES	CONC1	CONC1	CONC1	P8	11'-0"	WALLS	151
152	SALES	CONC1	CONC1	CONC1	P8	11'-0"	WALLS	152
153	SALES	CONC1	CONC1	CONC1	P8	11'-0"	WALLS	153
154	SALES	CONC1	CONC1	CONC1	P8	11'-0"	WALLS	154
155	SALES	CONC1	CONC1	CONC1	P8	11'-0"	WALLS	155
156	SALES	CONC1	CONC1	CONC1	P8	11'-0"	WALLS	156
157	SALES	CONC1	CONC1	CONC1	P8	11'-0"	WALLS	157
158	SALES	CONC1	CONC1	CONC1	P8	11'-0"	WALLS	158
159	SALES	CONC1	CONC1	CONC1	P8	11'-0"	WALLS	159
160	SALES	CONC1	CONC1	CONC1	P8	11'-0"	WALLS	160
161	SALES	CONC1	CONC1	CONC1	P8	11'-0"	WALLS	161
162	SALES	CONC1	CONC1	CONC1	P8	11'-0"	WALLS	162
163	SALES	CONC1	CONC1	CONC1	P8	11'-0"	WALLS	163
164	SALES	CONC1	CONC1	CONC1	P8	11'-0"	WALLS	164
165	SALES	CONC1	CONC1	CONC1	P8	11'-0"	WALLS	165
166	SALES	CONC1	CONC1	CONC1	P8	11'-0"	WALLS	166
167	SALES	CONC1	CONC1	CONC1	P8	11'-0"	WALLS	167
168	SALES	CONC1	CONC1	CONC1	P8	11'-0"	WALLS	168
169	SALES	CONC1	CONC1	CONC1	P8	11'-0"	WALLS	169
170	SALES	CONC1	CONC1	CONC1	P8	11'-0"	WALLS	170
171	SALES	CONC1	CONC1	CONC1	P8	11'-0"	WALLS	171
172	SALES	CONC1	CONC1	CONC1	P8	11'-0"	WALLS	172
173	SALES	CONC1	CONC1	CONC1	P8	11'-0"	WALLS	173
174	SALES	CONC1	CONC1	CONC1	P8	11'-0"	WALLS	174
175	SALES	CONC1	CONC1	CONC1	P8	11'-0"	WALLS	175
176	SALES	CONC1	CONC1	CONC1	P8	11'-0"	WALLS	176
177	SALES	CONC1	CONC1	CONC1	P8	11'-0"	WALLS	177
178	SALES	CONC1	CONC1	CONC1	P8	11'-0"	WALLS	178
179	SALES	CONC1	CONC1	CONC1	P8	11'-0"	WALLS	179
180	SALES	CONC1	CONC1	CONC1	P8	11'-0"	WALLS	180
181	SALES	CONC1	CONC1	CONC1	P8	11'-0"	WALLS	181
182	SALES	CONC1	CONC1	CONC1	P8	11'-0"	WALLS	182
183	SALES	CONC1	CONC1	CONC1	P8	11'-0"	WALLS	183
184	SALES	CONC1	CONC1	CONC1	P8	11'-0"	WALLS	184
185	SALES	CONC1	CONC1	CONC1	P8	11'-0"	WALLS	185
186	SALES	CONC1	CONC1	CONC1	P8	11'-0"	WALLS	186
187	SALES	CONC1	CONC1	CONC1	P8	11'-0"	WALLS	187
188	SALES	CONC1	CONC1	CONC1	P8	11'-0"	WALLS	188
189	SALES	CONC1	CONC1	CONC1	P8	11'-0"	WALLS	189
190	SALES	CONC1	CONC1	CONC1	P8	11'-0"	WALLS	190
191	SALES	CONC1	CONC1	CONC1	P8	11'-0"	WALLS	191
192	SALES	CONC1	CONC1	CONC1	P8	11'-0"	WALLS	192
193	SALES	CONC1	CONC1	CONC1	P8	11'-0"	WALLS	193
194	SALES	CONC1	CONC1	CONC1	P8	11'-0"	WALLS	194
195	SALES	CONC1	CONC1	CONC1	P8	11'-0"	WALLS	195
196	SALES	CONC1	CONC1	CONC1	P8	11'-0"	WALLS	196
197	SALES	CONC1	CONC1	CONC1	P8	11'-0"	WALLS	197
198	SALES	CONC1	CONC1	CONC1	P8	11'-0"	WALLS	198
199	SALES	CONC1	CONC1	CONC1	P8	11'-0"	WALLS	199
200	SALES	CONC1	CONC1	CONC1	P8	11'-0"	WALLS	200
201	SALES	CONC1	CONC1	CONC1	P8	11'-0"	WALLS	201
202	SALES	CONC1	CONC1	CONC1	P8	11'-0"	WALLS	202
203	SALES	CONC1	CONC1	CONC1	P8	11'-0"	WALLS	203
204	SALES	CONC1	CONC1	CONC1	P8	11'-0"	WALLS	204
205	SALES	CONC1	CONC1	CONC1	P8	11'-0"	WALLS	205
206	SALES	CONC1	CONC1	CONC1	P8	11'-0"	WALLS	206
207	SALES	CONC1	CONC1	CONC1	P8	11'-0"	WALLS	207
208	SALES	CONC1	CONC1	CONC1	P8	11'-0"	WALLS	208
209	SALES	CONC1	CONC1	CONC1	P8	11'-0"	WALLS	209
210	SALES	CONC1	CONC1	CONC1	P8	11'-0"	WALLS	210
211	SALES	CONC1	CONC1	CONC1	P8	11'-0"	WALLS	211
212	SALES	CONC1	CONC1	CONC1	P8	11'-0"	WALLS	212
213	SALES	CONC1	CONC1	CONC1	P8	11'-0"	WALLS	213
214	SALES	CONC1	CONC1	CONC1	P8	11'-0"	WALLS	214
215	SALES	CONC1	CONC1	CONC1	P8	11'-0"	WALLS	215
216	SALES	CONC1	CONC1	CONC1	P8	11'-0"	WALLS	216
217	SALES	CONC1	CONC1	CONC1	P8	11'-0"	WALLS	217
218	SALES	CONC1	CONC1	CONC1	P8	11'-0"	WALLS	218
219	SALES	CONC1	CONC1	CONC1	P8	11'-0"	WALLS	219
220	SALES	CONC1	CONC1	CONC1	P8	11'-0"	WALLS	220
221	SALES	CONC1	CONC1	CONC1	P8	11'-0"	WALLS	221
222	SALES	CONC1	CONC1	CONC1	P8	11'-0"	WALLS	222
223	SALES	CONC1	CONC1	CONC1	P8	11'-0"	WALLS	223
224	SALES	CONC1	CONC1	CONC1	P8	11'-0"	WALLS	224
225	SALES	CONC1	CONC1	CONC1	P8	11'-0"	WALLS	225
226	SALES	CONC1	CONC1	CONC1	P8	11'-0"	WALLS	226
227	SALES	CONC1	CONC1	CONC1	P8	11'-0"	WALLS	227
228	SALES	CONC1	CONC1	CONC1	P8	11'-0"	WALLS	228
229	SALES	CONC1	CONC1	CONC1	P8	11'-0"	WALLS	229
230	SALES	CONC1	CONC1	CONC1	P8	11'-0"	WALLS	230
231	SALES	CONC1	CONC1	CONC1	P8	11'-0"	WALLS	231
232	SALES	CONC1	CONC1	CONC1	P8	11'-0"	WALLS	232
233	SALES	CONC1	CONC1	CONC1	P8	11'-0"	WALLS	233

FINISH LEGEND

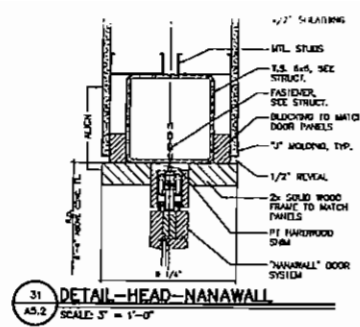

31 DETAIL - HEAD - NANAWALL
AS.2 SCALE: 3\"/>

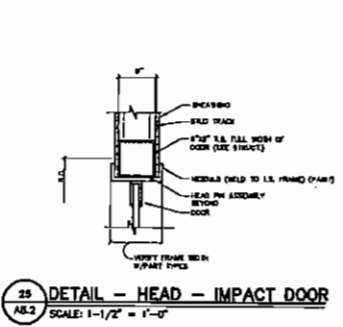

28 DETAIL - HEAD - IMPACT DOOR
AS.2 SCALE: 1-1/2\"/>

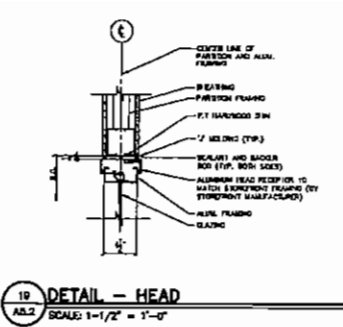

19 DETAIL - HEAD
AS.2 SCALE: 1-1/2\"/>

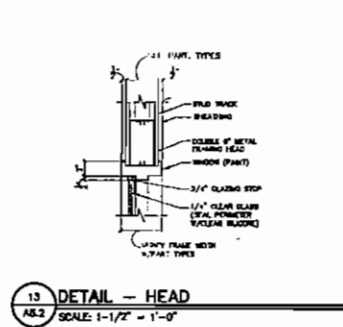

13 DETAIL - HEAD
AS.2 SCALE: 1-1/2\"/>

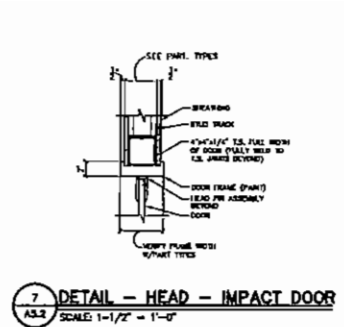

7 DETAIL - HEAD - IMPACT DOOR
AS.2 SCALE: 1-1/2\"/>

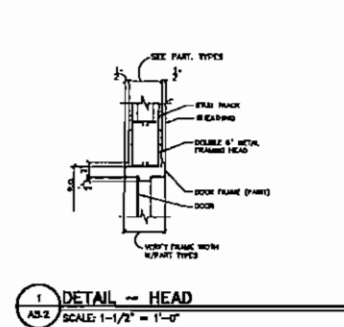

1 DETAIL - HEAD
AS.2 SCALE: 1-1/2\"/>

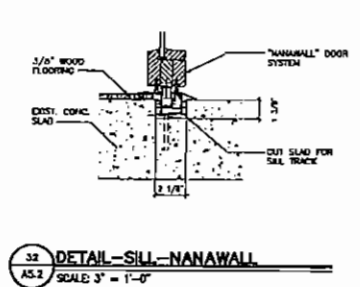

32 DETAIL - SILL - NANAWALL
AS.2 SCALE: 3\"/>

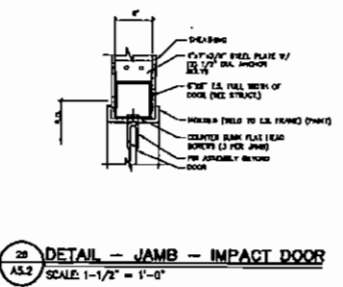

29 DETAIL - JAMB - IMPACT DOOR
AS.2 SCALE: 1-1/2\"/>

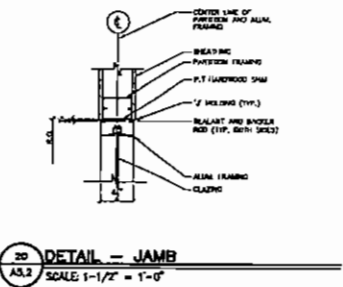

20 DETAIL - JAMB
AS.2 SCALE: 1-1/2\"/>

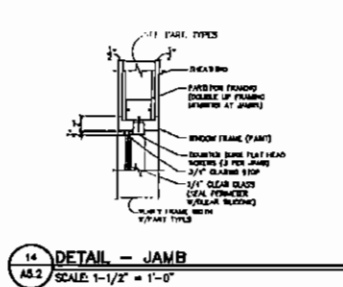

14 DETAIL - JAMB
AS.2 SCALE: 1-1/2\"/>

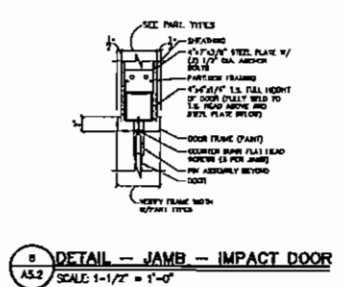

8 DETAIL - JAMB - IMPACT DOOR
AS.2 SCALE: 1-1/2\"/>

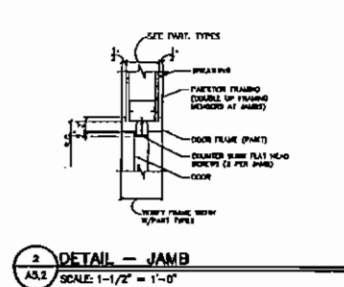

2 DETAIL - JAMB
AS.2 SCALE: 1-1/2\"/>

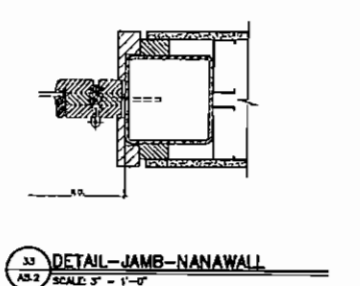

33 DETAIL - JAMB - NANAWALL
AS.2 SCALE: 3\"/>

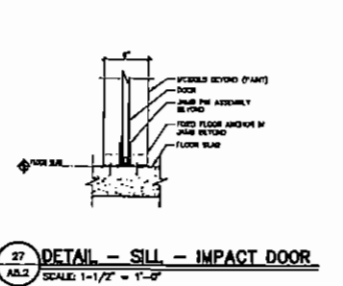

27 DETAIL - SILL - IMPACT DOOR
AS.2 SCALE: 1-1/2\"/>

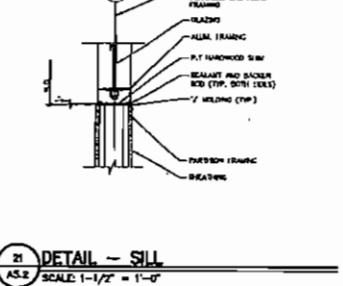

21 DETAIL - SILL
AS.2 SCALE: 1-1/2\"/>

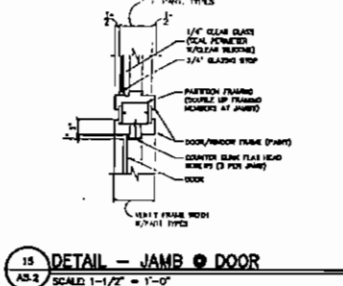

15 DETAIL - JAMB - DOOR
AS.2 SCALE: 1-1/2\"/>

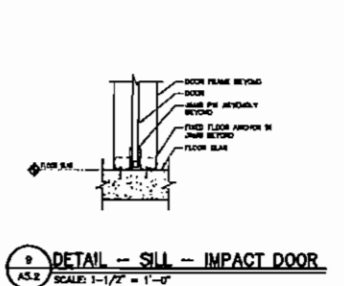

9 DETAIL - SILL - IMPACT DOOR
AS.2 SCALE: 1-1/2\"/>

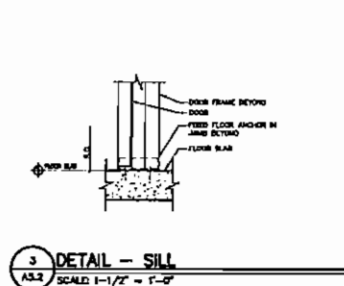

3 DETAIL - SILL
AS.2 SCALE: 1-1/2\"/>

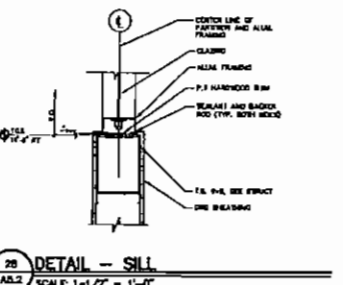

28 DETAIL - SILL
AS.2 SCALE: 1-1/2\"/>

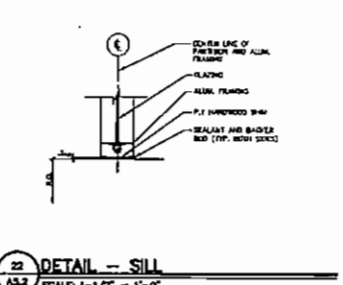

22 DETAIL - SILL
AS.2 SCALE: 1-1/2\"/>

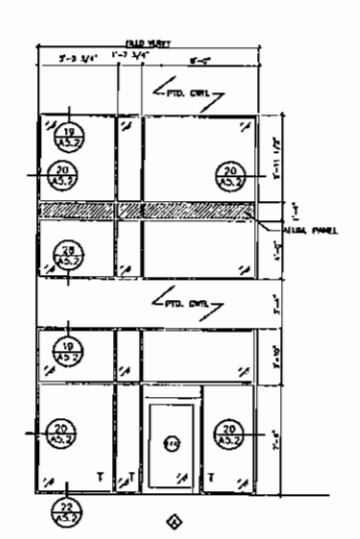

36 WINDOW AND STOREFRONT DETAILS
AS.2 SCALE: 1/4\"/>

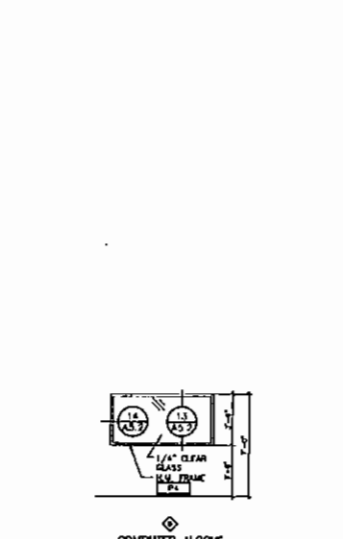

30 COMPUTER ALCOVE
AS.2 SCALE: 1/4\"/>

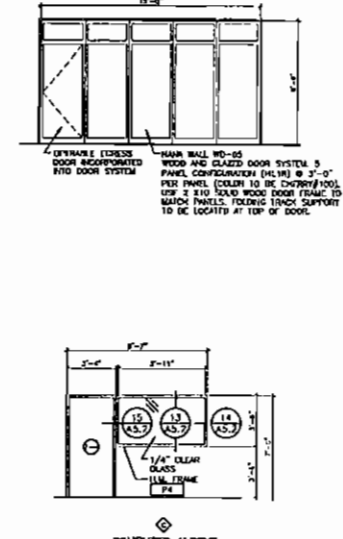

31 COMPUTER ALCOVE
AS.2 SCALE: 1/4\"/>

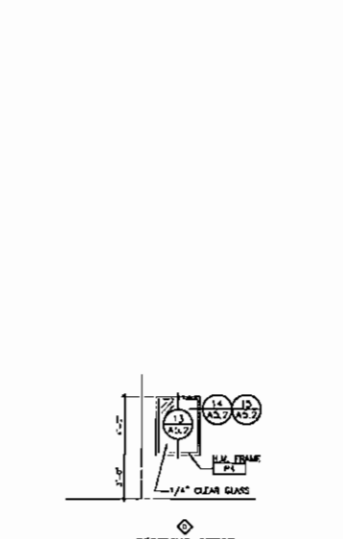

32 RECEIVING OFFICE
AS.2 SCALE: 1/4\"/>

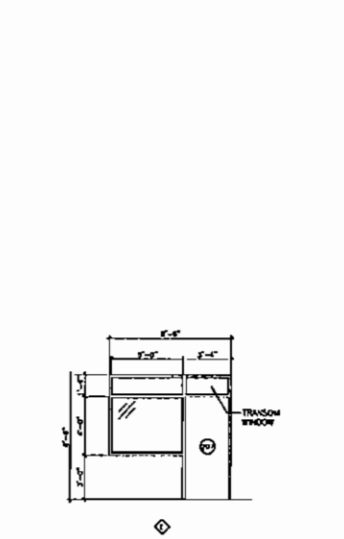

33 ASTL/STL OFFICE
AS.2 SCALE: 1/4\"/>

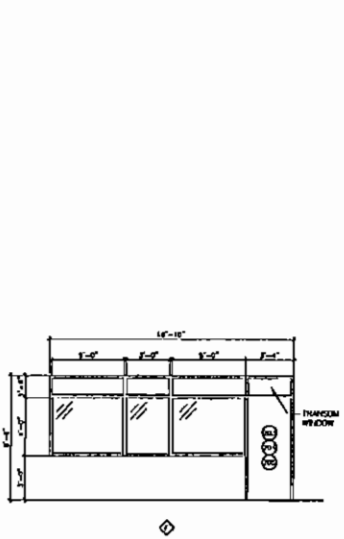

34 SIGN MAKER/MARKETING, CONF. ROOM, TLS OFFICE
AS.2 SCALE: 1/4\"/>

NOTE: SEE SHEET AS.0 FOR FINISH LEGEND

TO ORDER PLANS GO TO WWW.LDIREPRO.COM

PROFESSIONAL SEAL

PROFESSIONAL OF ENGINEER
KYLE S. HOPKIN
REGISTERED ARCHITECT
ALAN WELLS
QUALITY ENGINEER
SABIRI QURESHI
DESIGNED BY
JERRY ANDERSON/ALAN JONES

PROJECT NAME

NASHVILLE
TENNESSEE
HILL CENTER

WHOLE
FOODS
MARKET

PROJECT NUMBER
20050458
SHEET TITLE

DOOR/WINDOW
DETAILS

SHEET NUMBER
AS.2

