

1 CONTROL DIAGRAM - TEACHING WING B LABORATORY EXHAUST SYSTEM
SCALE: NONE

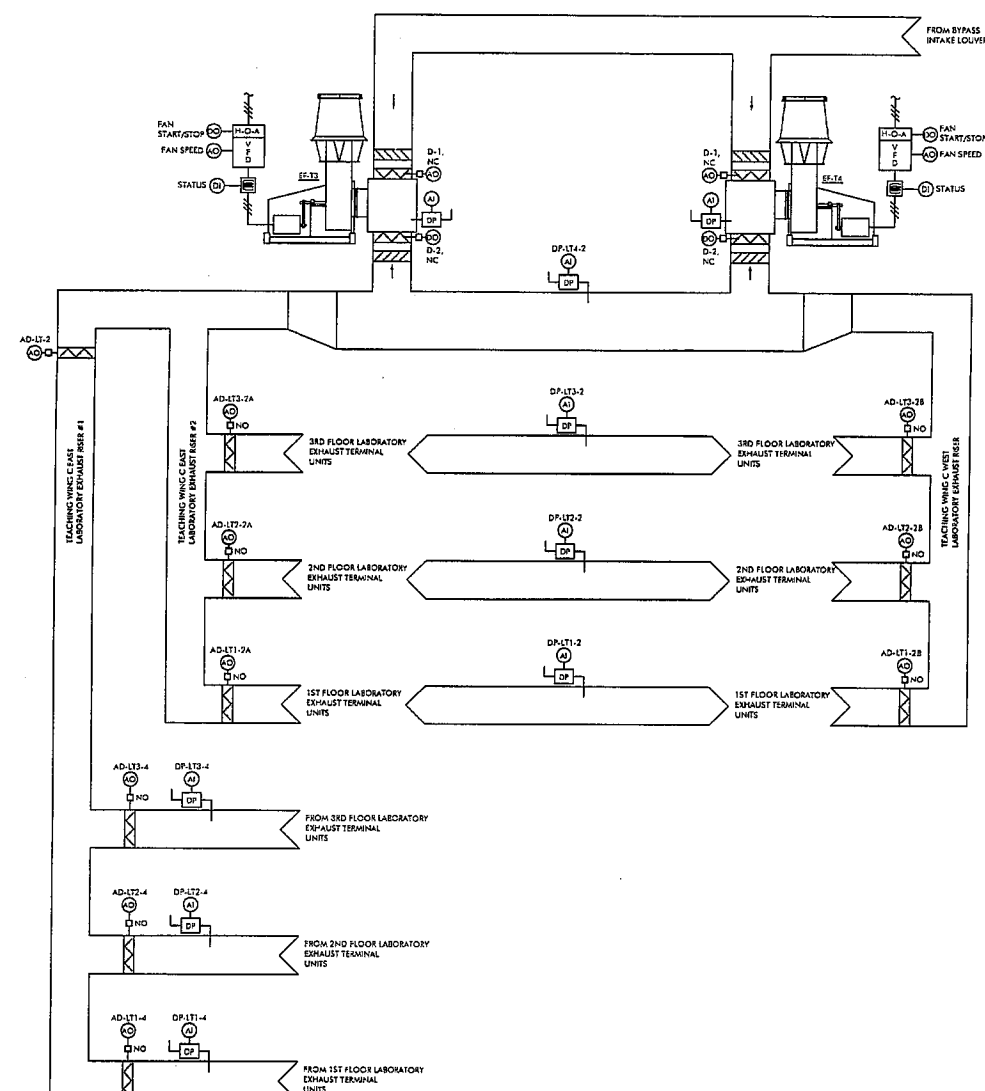

2 CONTROL DIAGRAM - TEACHING WING C LABORATORY EXHAUST SYSTEM
SCALE: NONE

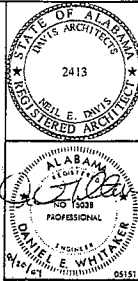

SCIENCE & ENGINEERING COMPLEX - PHASE I
 BID PACKAGE #2
 THE UNIVERSITY OF ALABAMA, TUSCALOOSA, ALABAMA
 UA PROJECT # 234-04-093 / BC # 2006420

DAVIS ARCHITECTS
 100 UNIVERSITY BLVD
 TUSCALOOSA, AL 35602
 TEL: 205-756-1000
 FAX: 205-756-1001

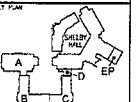

CONTROL DIAG.
 SEC B & C
 LAB EXHAUST

AUGUST 20, 2007

100% SERVICE C

DATE	CREATED	APPROVED
	22	22

PROJECT NO. 3462

DATE: 297
 SCALE: M6.8
 SHEET: 457

Whittaker & Rowson, Inc.
 2132 Old Montgomery Hwy
 Suite 103 Mark Harris Bldg
 Birmingham, AL 35209
 Phone: 205-975-2001
 Fax: 205-975-0091
 www.w-r.com

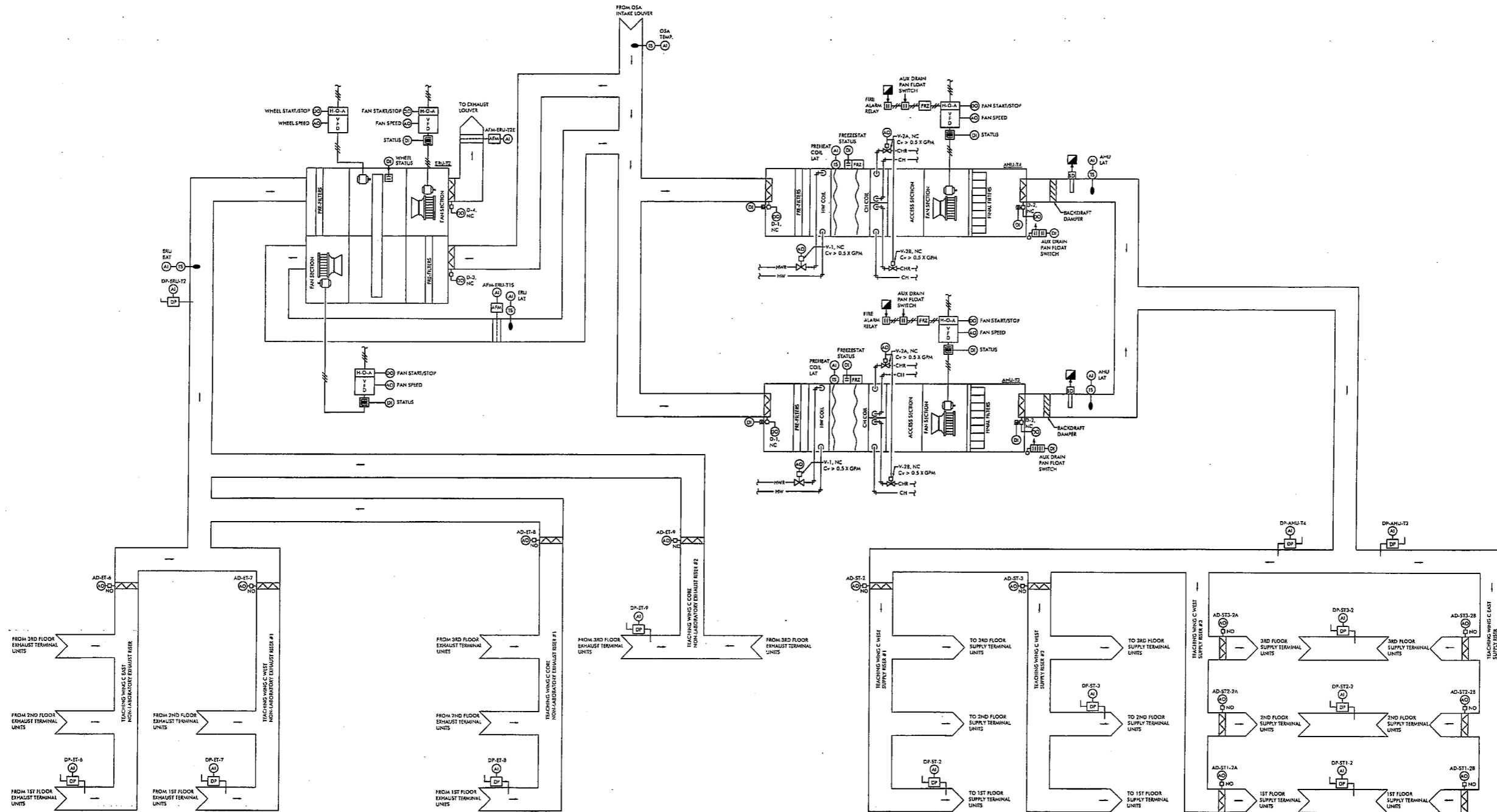

1 CONTROL DIAGRAM - TEACHING WING C SUPPLY AIR & NON-LABORATORY EXHAUST SYSTEM
M&9 SCALE: NONE

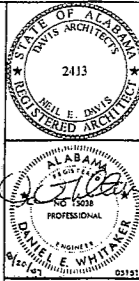

SCIENCE & ENGINEERING COMPLEX - PHASE I
 BID PACKAGE #2
 THE UNIVERSITY OF ALABAMA, TUSCALOOSA, ALABAMA
 UA PROJECT # 234-04-095 / BC # 2006420

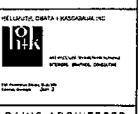

DAVIS ARCHITECTS
 DAVIS ARCHITECTS, INC.
 100 UNIVERSITY BLVD, SUITE 200
 TUSCALOOSA, AL 35602
 TEL: 205-763-1111
 FAX: 205-763-1112
 WWW.DAVIS-ARCH.COM

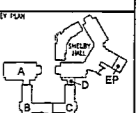

CONTROL DIAG.
 SEC C SUPPLY AIR
 & NON-LAB EXH.
 AUGUST 20, 2007

DATE	DESIGNED	APPROVED
	2007	2007
PROJECT NO.	3462	

DATE	298
PROJECT NO.	M6.9
ED PACKAGE #2	457

Whittaker & Rawson, Inc.
 3332 Old Montgomery Hwy
 Suite 103 Markham Plaza
 Birmingham, AL 35209
 Phone: 205-876-4341
 Fax: 205-876-4341
 www.whittakerandrawson.com